

Fig. 3 REAR PANEL

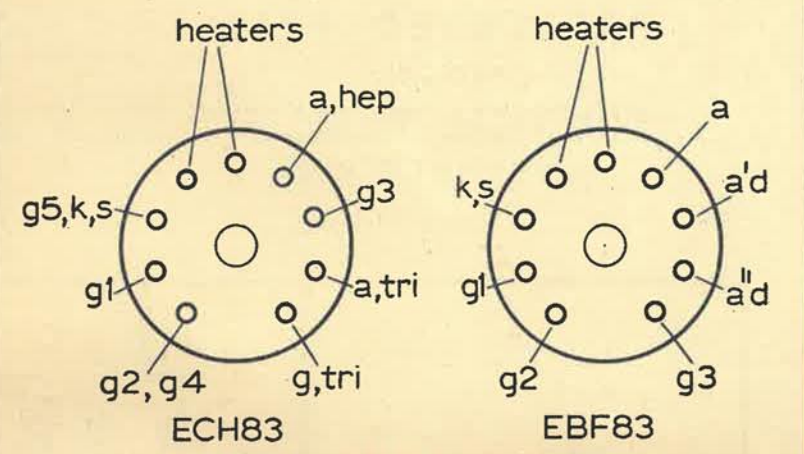

Fig. 7 VALVE BASES

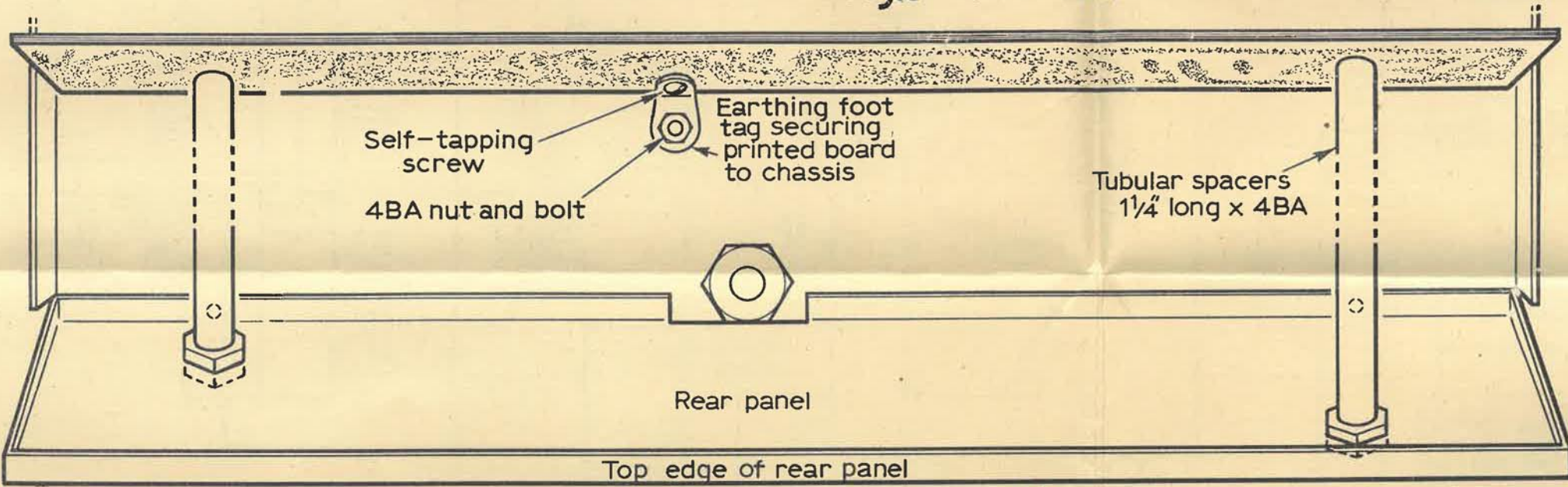

Fig. 4 SECURING PRINTED CIRCUIT BOARD

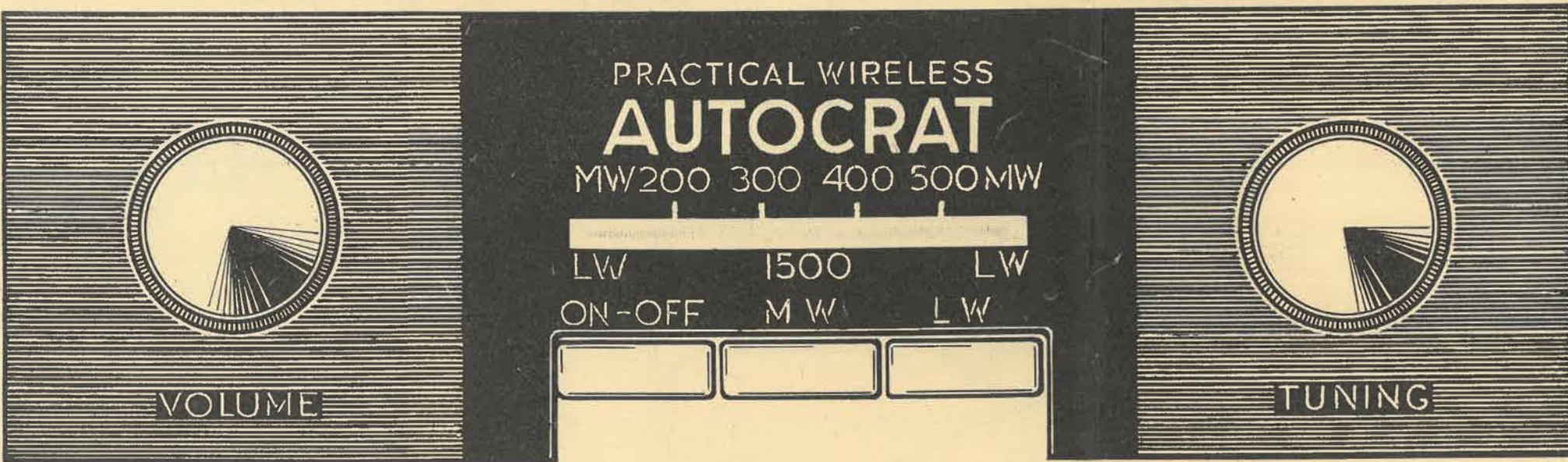

Fig. 5 FRONT VIEW

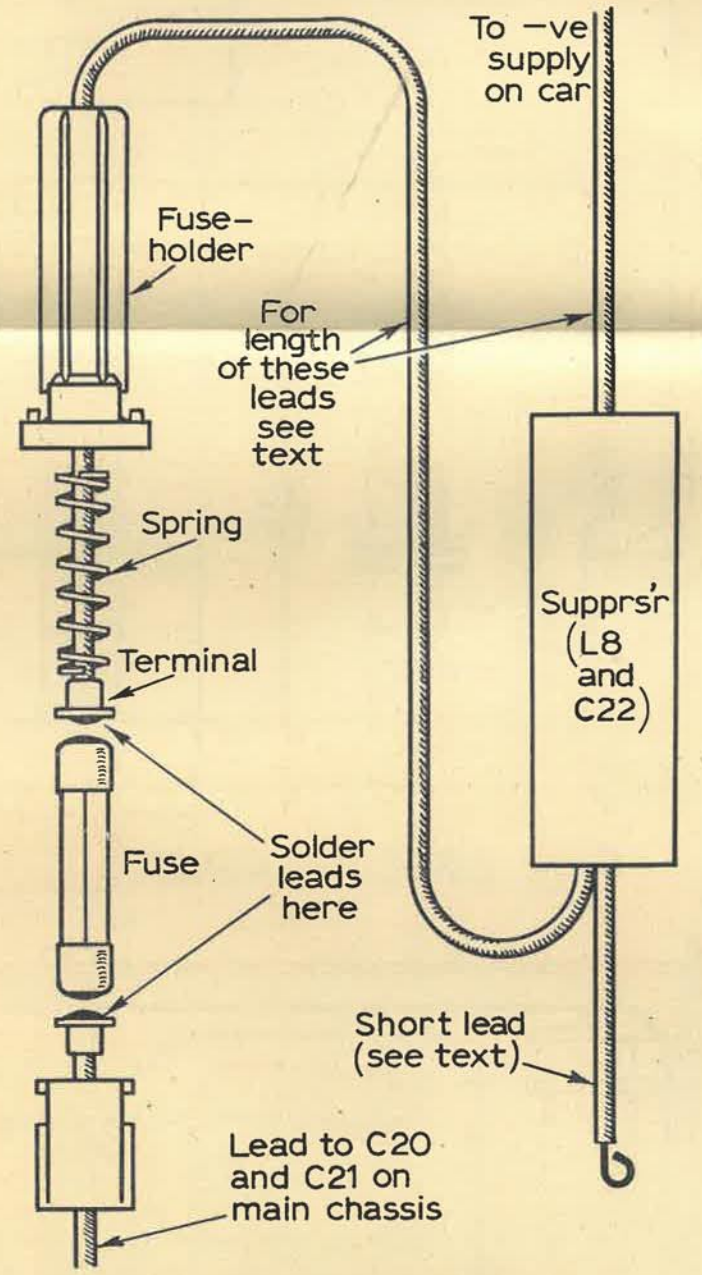

Fig. 8 SUPPRESSOR AND FUSE-HOLDER ASSEMBLY

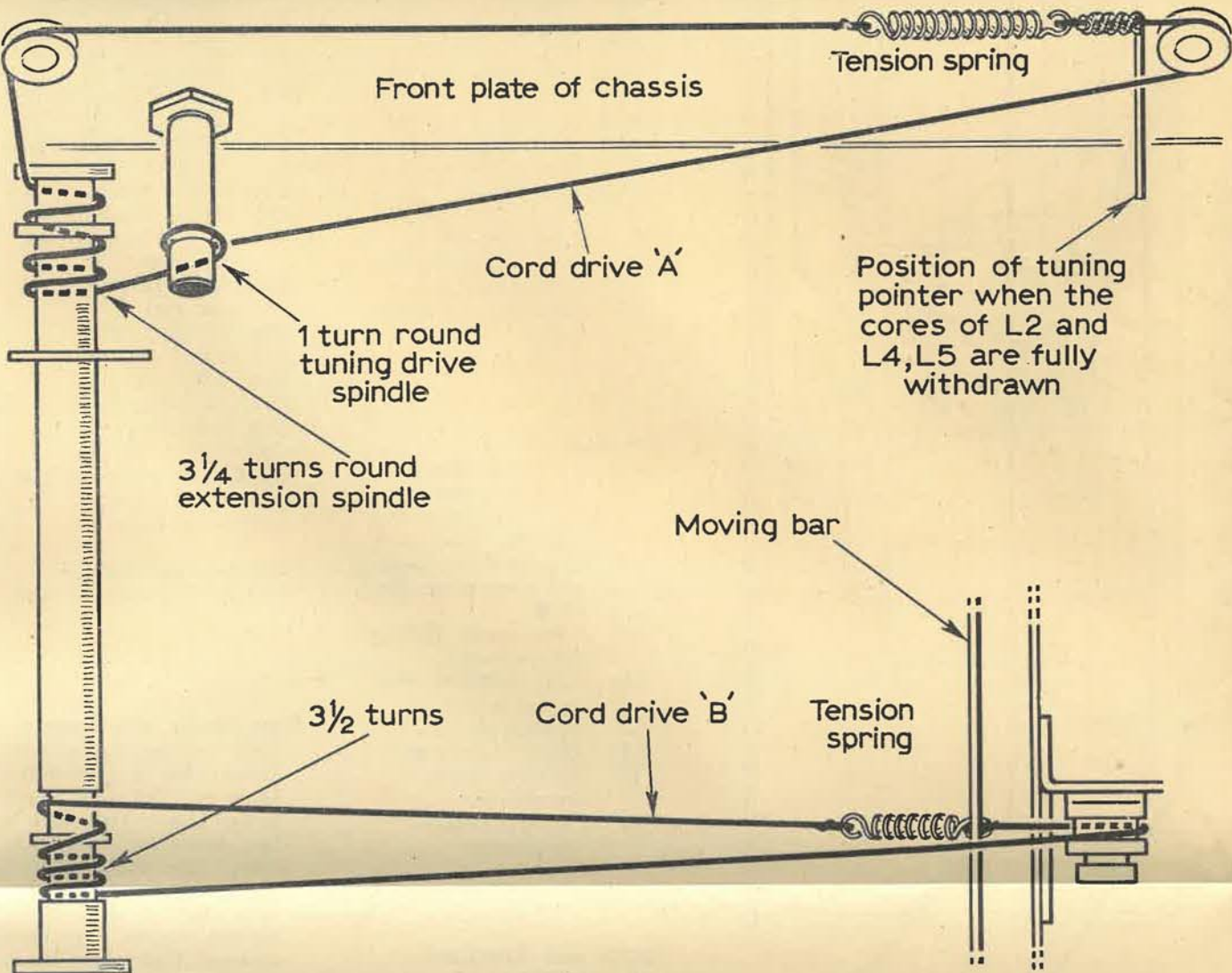

Fig. 6 CORD DRIVE DETAILS

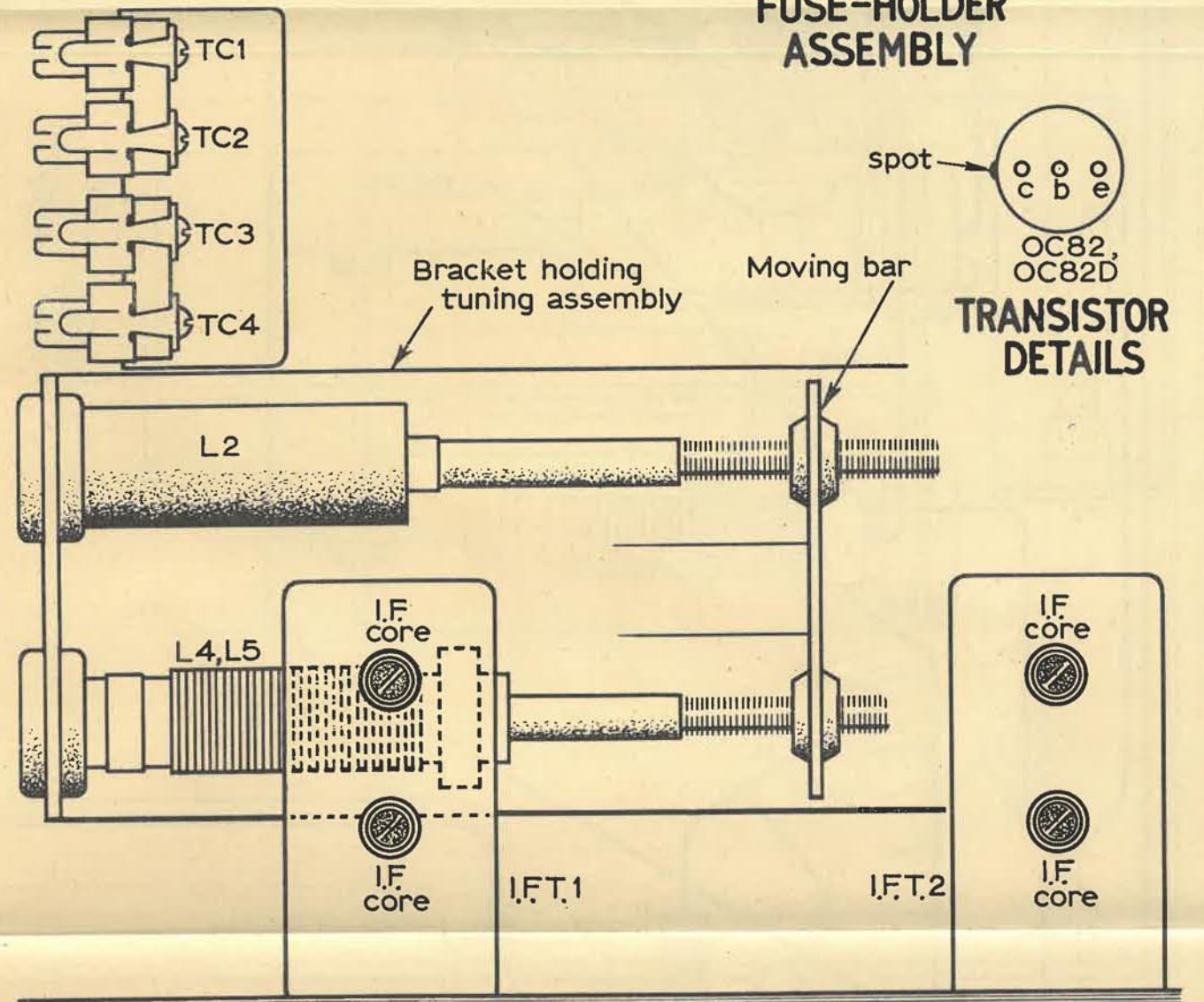

Fig. 9 ALIGNMENT DIAGRAM

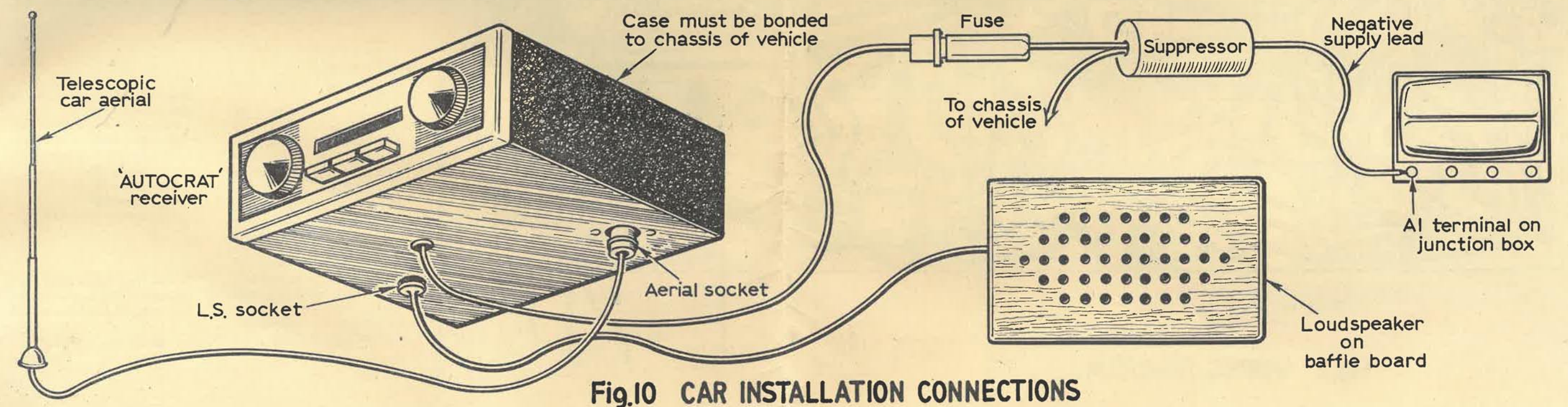

Fig. 10 CAR INSTALLATION CONNECTIONS